

# MOUVANCE

## Portail

### Rail de guidage

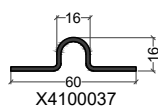

### Clips feuillures

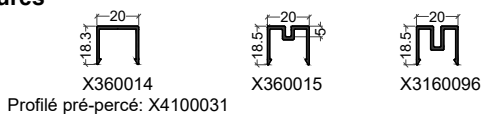

### Clip montant

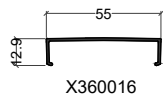

### Renforts

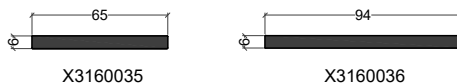

### Montants

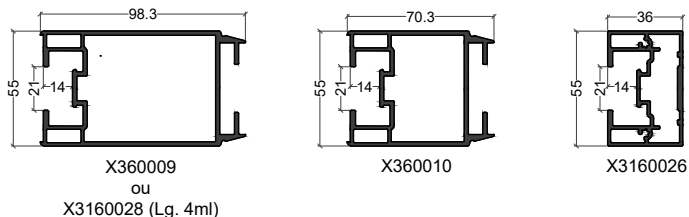

### Traverses

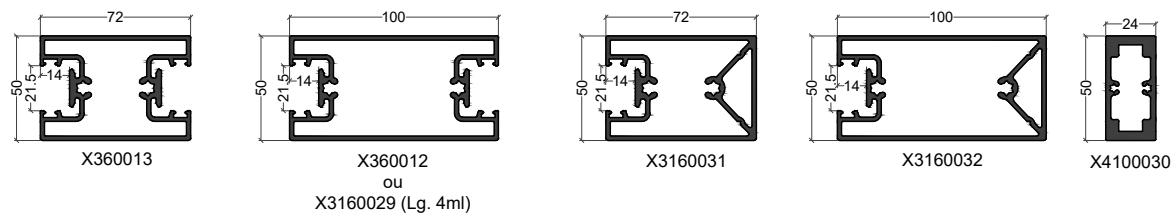

### Lames / Barreaudage

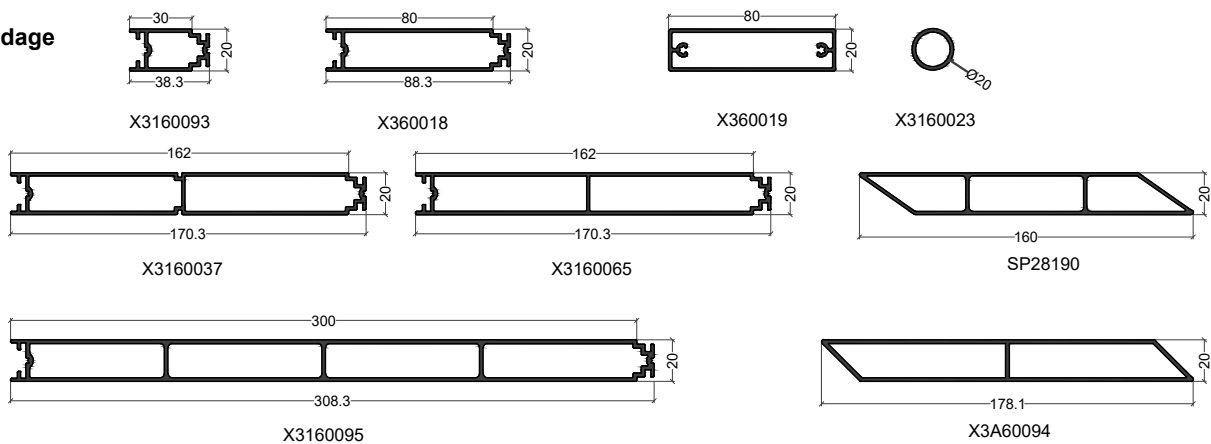

### Poteaux

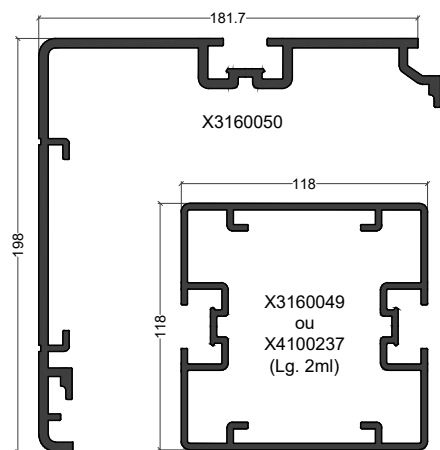

### Battement

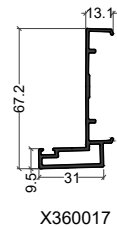

### Profilé de guidage

